

Display Unit

**SCHMIDT**  
control instruments



Edition SCD-1 04-1.0.E

SC Series

Model SCD-1

# Instruction Manual

Valid as of: 01.01.2013 • Please keep the manual for future reference!

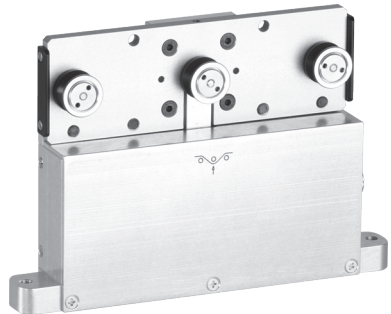
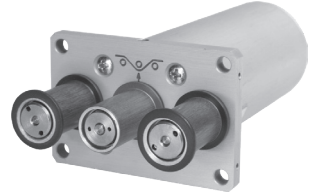
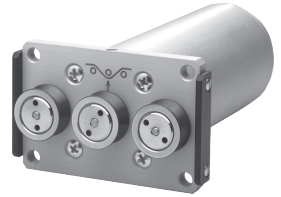

SCHMIDT · 1<sup>ST</sup> IN TENSIONMETERS WORLDWIDE

# Contents

<b>1</b>	<b>Warranty and liability</b> .....	<b>3</b>
1.1	Notices within the instruction manual .....	3
1.2	Responsibilities of the operating company .....	3
1.3	Responsibilities of the personnel .....	3
1.4	Informal safety measures .....	4
1.5	Training of the personnel .....	4
1.6	Intended use .....	4
1.7	Dangers in handling the device .....	4
1.8	Copyright .....	4
1.9	Declaration of conformity, RoHs II and WEEE registration .....	4
<b>2</b>	<b>General information</b> .....	<b>5</b>
2.1	Specifications .....	5
2.2	Pin assignments of the connectors .....	5
2.2.1	Pin assignment of the Green Mini-DIN port (min., max. and analog output) .....	5
2.2.2	Pin assignment of the purple Mini-DIN port (RS-232 and Analog Interface) .....	6
2.2.3	Pin assignment of the connectors for TS, FS and MZ sensors .....	6
2.3	Delivery includes .....	6
2.3.1	Optional accessories: .....	6
2.3.2	EK0648 pin assignment and wire colors .....	6
2.4	Unpacking .....	7
2.5	Stationary mounting of the SCD-1 .....	7
<b>3</b>	<b>Operation</b> .....	<b>8</b>
3.1	Operating elements .....	8
3.1.1	Switch-on .....	8
3.1.2	Switch-off .....	8
3.2	Operating procedure .....	9
3.3	Settings .....	10
3.3.1	Changing the settings .....	11
3.4	Calibration of sensors of the TS, FS and MZ series .....	14
3.4.1	Zero adjustment .....	14
3.4.2	Zero and gain adjustment .....	15
3.4.3	Restoring the factory calibration .....	16
<b>4</b>	<b>Interfaces</b> .....	<b>16</b>
4.1	Analog interface .....	16
4.2	Min. - max. interface .....	16
4.3	Digital interface .....	17
4.3.1	The »Tension Inspect 3« program .....	17
4.3.2	Windows terminal program .....	17
4.4	Online sensor specifications .....	17
<b>5</b>	<b>Service and maintenance</b> .....	<b>18</b>
<b>6</b>	<b>Cleaning</b> .....	<b>18</b>
<b>7</b>	<b>Verification intervals</b> .....	<b>18</b>
<b>8</b>	<b>Correspondence</b> .....	<b>18</b>
<b>9</b>	<b>Repairs</b> .....	<b>18</b>

## **1 Warranty and liability**

In principle, the supply of the device is subject to our “General Conditions of Sale and Delivery.” These have been provided to the operating company on conclusion of the contract, at the latest.

Warranty:

- SCHMIDT display units are warranted for 12 months.
- Parts subject to wear, electronic components and measuring springs are not covered by the warranty. No warranty or liability will be accepted for bodily injury or property damage resulting from one or several of the following causes:
- Misuse or abuse of the device.
- Improper mounting, commissioning, operation and maintenance of the device (e.g. verification interval).
- Operation of the device if any safeguards are defective or if any safety and protection precautions are not properly installed or not operative.
- Failure to comply with the notices in the instruction manual regarding transport, storage, mounting, commissioning, operation, maintenance and setup of the device.
- Any unauthorized structural alteration of the device.
- Insufficient inspection of device components that are subject to wear.
- Opening the device or improper repair work.
- Disasters caused by the effects of foreign objects or by force majeure.

### **1.1 Notices within the instruction manual**

The fundamental prerequisite for the safe handling of this device and its troublefree operation is the knowledge of the basic safety notices and safety instructions.

These instruction manual contain the most important notices for the safe operation of the device.

These instruction manual, in particular the safety notices, must be observed by any person who works with the device. In addition, the local valid rules and regulations for the prevention of accidents must be complied with.

The representations within the instruction manual are not true to scale.

The dimensions given are not binding.

General indications of direction, such as FRONT, REAR, RIGHT, LEFT apply when viewing the front of the device.

### **1.2 Responsibilities of the operating company**

In compliance with the EC Directive 89 / 655 / EEC, the operating company agrees to only permit persons to work with the device who:

- are familiar with the basic regulations on industrial safety and accident prevention and who have been trained in handling the device.
- have read and understood the chapter on safety and the warning notices in these instruction manual and have confirmed this with their signatures.
- are examined regularly on their safe and conscientious working method.

### **1.3 Responsibilities of the personnel**

All persons who work with the device agree to perform the following duties before starting work:

- to observe the basic regulations on industrial safety and accident prevention.
- to read the chapter on safety and the warning notices in these instruction manual and to confirm with their signatures that they have understood them.

## 1.4 Informal safety measures

The instruction manual must always be kept on hand where the device is operated. Apart from the instruction manual, the general and local valid regulations on accident prevention and environmental protection must be provided and complied with.

## 1.5 Training of the personnel

Only trained and instructed personnel is permitted to work with the device. The responsibilities of the personnel must be clearly defined for mounting, commissioning, operation, setup, maintenance, and repair. Trainees may only work with the device under the supervision of experienced personnel.

## 1.6 Intended use

The device is intended exclusively for displaying tension values measured by the online sensors from Hans Schmidt & Co GmbH. Any use with sensors from other manufacturers or any use exceeding this intention will be regarded as misuse. Under no circumstances shall Hans Schmidt & Co GmbH be held liable for damage resulting from misuse.

The intended use also includes:

- Complying with all notices included in the instruction manual and observing all inspection and maintenance works.

## 1.7 Dangers in handling the device

The device was designed according to the state of the art and the approved safety standards. Nevertheless, its use may cause serious or fatal injury to the user or third persons, and/or an impairment of the device or of other material assets.

The device may only be applied:

- For its intended use in a faultless condition with regard to the safety requirements.
- Malfunctions that could impair safety must be remedied immediately.
- Personal protective equipment must be used according to the EC Directive 89/686/EEC.



**The device must not be operated in potential explosive areas and must not come into contact with aggressive substances.**

## 1.8 Copyright

The copyright on these instruction manual remains with the company Hans Schmidt & Co GmbH.

These instruction manual is intended for the operating company and its personnel only. They contain instructions and notices that may only be reproduced on the prior written permission of

Hans Schmidt & Co GmbH

and under indication of the complete reference data.

Violations will be prosecuted.

## 1.9 Declaration of conformity, RoHs II and WEEE registration

In compliance with the EU Directives 2014/30/EU and 2011/65/EU



**Hans Schmidt & Co GmbH is registered in compliance with the German Electrical and Electronic Equipment Act (ElektroG) under WEEE Reg. No. DE 48092317.**

## 2 General information

### 2.1 Specifications

<b>Digital display:</b>	Dot matrix LCD, height of digit 12 mm with backlight
<b>Units of measure:</b>	cN, daN, g or kg (selectable)
<b>Damping (<math>f_g</math>):</b>	16-step adjustable
<b>Analog output signal :</b>	0 - 10 V DC / $R_{Load} \geq 5K \text{ Ohm}$
<b>Alarm limits:</b>	High / Low (selectable), with output signal open collector max. 30 V DC, 10 mA
<b>Digital output signal:</b>	RS-232 (19200, 8, N, 1) (approx. 80 readings per sec)
<b>Voltage output for sensor:</b>	Yes
<b>Power supply:</b>	15 - 24 V DC, 100 mA AC adapter 100 - 240 V AC, 50 - 60 Hz with 3 adapters (EU/USA/UK)
<b>Temperature range:</b>	10 - 45° C
<b>Air humidity:</b>	85 % RH, max
<b>Housing:</b>	Aluminium
<b>Dimensions:</b>	182 x 85 x 34 mm (L x W x H)
<b>Weight, net (gross):</b>	Approx. 300 g (1000 g)

### 2.2 Pin assignments of the connectors



The cable connecting the sensor with the display unit must be shielded. The shield of the connecting cable must be connected to the metal housing of the connecting plug.

Connect only sensors which comply with the specifications given in chapter 5.

To avoid random noise and malfunctions, make sure the cable connecting the SCD-1 with the sensor is not laid parallel to power lines or highly loaded signal lines, regardless of the type of voltage.



The requirements of the CE specification are only complied with if the SCD-1 is equipped and operated with sensors and connecting cables supplied by Hans Schmidt & Co GmbH. Certification to the CE specification does not extend to, and shall be invalid for any other combination. Under no circumstances shall Hans Schmidt & Co GmbH be held liable for any resulting damage.

#### 2.2.1 Pin assignment of the green Mini-DIN port (min., max. and analog output)

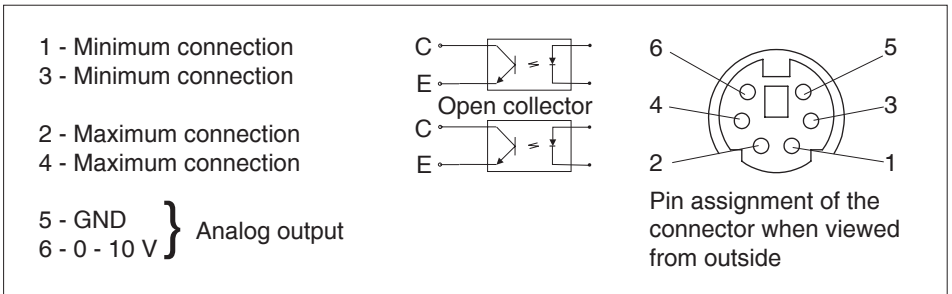

## 2.2.2 Pin assignment of the purple Mini-DIN port (RS-232 and Analog Interface)

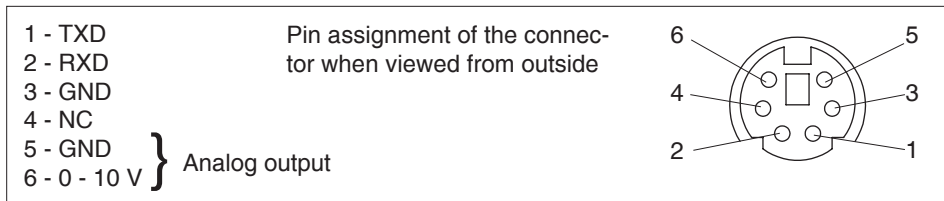

## 2.2.3 Pin assignment of the connectors for TS, FS and MZ sensors

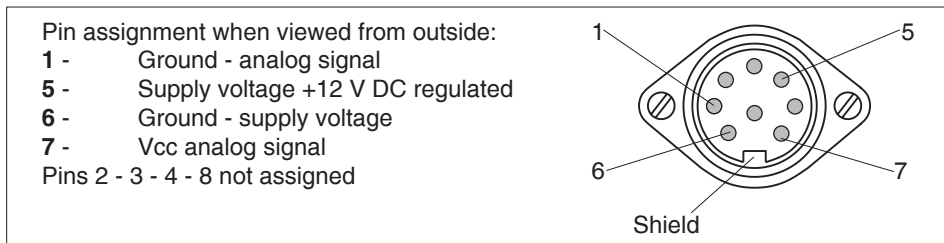

## 2.3 Delivery includes

- SCD-1 tension indicator
- AC adapter
- Instruction manual

### 2.3.1 Optional accessories:

- EK0603** Connecting cable for TS sensor with 2 diode plugs, length 3 m
- EK0605** Connecting cable for TS sensor with 2 diode plugs, length 5 m
- EK0610** Connecting cable for TS sensor with 2 diode plugs, length 10 m
- EK0624** Connecting cable for FS sensor with diode plug and sub-miniatur connector, length 2 m
- EK0647:** RS-232 connecting cable
- EK0648:** SCD-1 min. - max. and analog cable
- SW-TI3:** »Tension Inspect 3« software (Windows 7 or higher) for viewing and storing the measured data on a PC

### 2.3.2 EK0648 pin assignment and wire colors

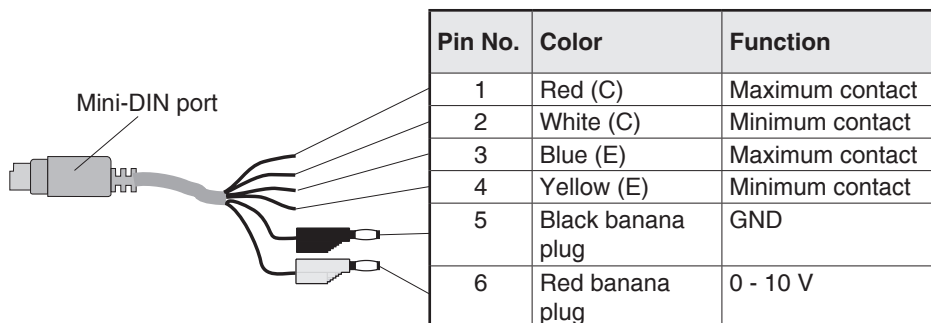

## 2.4 Unpacking

Unpack the display unit and inspect it for any shipping damage. Notices of defect must be announced immediately, in writing, at the latest within 7 days on receipt of the goods.

## 2.5 Stationary mounting of the SCD-1

The SCD-1 can also be used for stationary applications, if required. For this purpose, screw the mounting plates (included) to the back of the unit. Then fix the unit in place at the desired measuring position with two screws.

The dimensions of the threaded holes are given in fig. 2.6.

Be careful not to exceed the maximum depth of thread (8 mm) when mounting the unit.

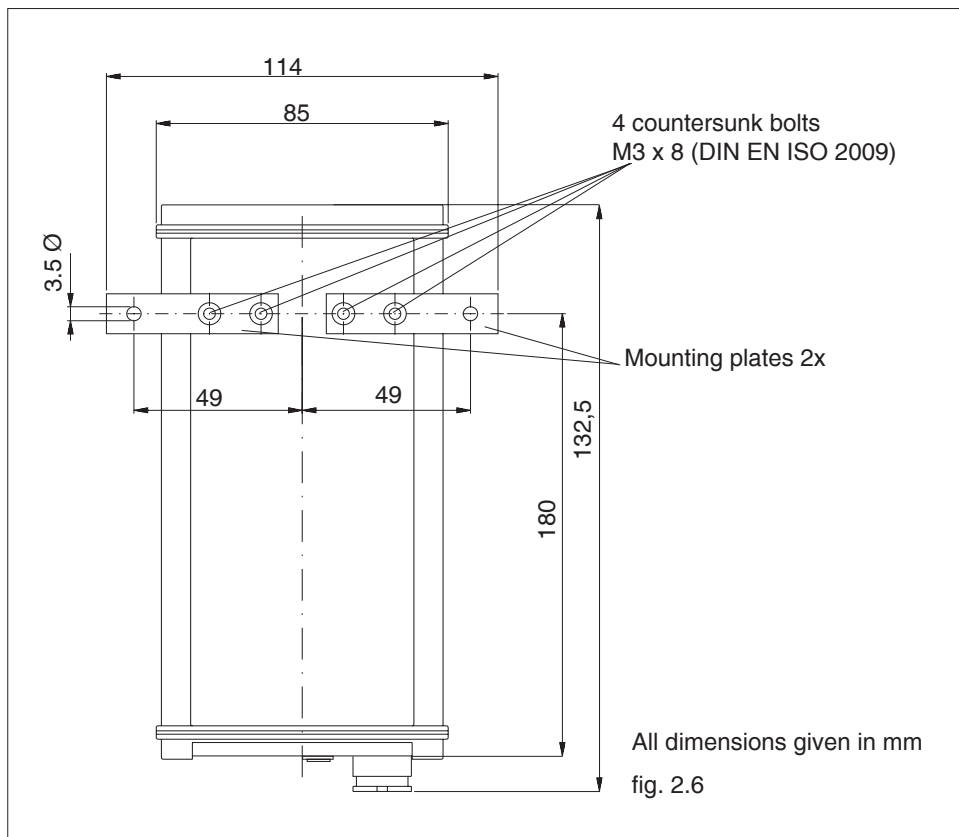

### 3 Operation

#### 3.1 Operating elements





##### 3.1.1 Switch-on

###### Requirements:

- AC adapter connected to the SCD-1.
- Sensor connected to the SCD-1.

- Press the  key.

The LCD momentarily shows  the version number and  the selected tension range. It then changes to measuring mode.

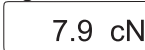
The LCD displays  the tension value.

##### 3.1.2 Switch-off

###### Manual switch-off:

- Press the  key for approx. five seconds.

The LCD displays  and then switches off immediately.

## 3.2 Operating procedure



Have you read and understood the instruction manual, in particular chapter 1 “Warranty and liability”? You are not permitted to operate the device before doing so.

Before working with the device you must put on your personal protective clothing, if necessary. For example, eye protectors, gloves, etc.

The cable connecting the sensor with the display unit must be shielded. The shield of the connecting cable must be connected to the metal housing of the connecting plug.

Connect only sensors which comply with the specifications given in chapter 4.4.

To avoid random noise and malfunctions, make sure the cable connecting the SCD-1 with the sensor is not laid parallel to power lines or highly loaded signal lines, regardless of the type of voltage.

**1** The ID plate with the CE mark and the serial number as well as the calibration label (optional) and the SCHMIDT Quality Seal are provided on the rear side of the instrument.

If a longer connecting cable should be required to connect the sensor with the SCD-1, you will find the pin assignment of the 8-pin connector in the specifications given in chapter 2.2.3.

- Install the sensor at the desired measuring location.
- Connect the SCD-1 to the supplied sensor.
- Connect the AC adapter.

- Press the  key to switch on the unit.
- Select the tension range as described in chapter 3.3.1. (only necessary when using the unit for the first time or after a sensor change)
- Allow approx. 10 min. for thermal stabilization of the unit.
- If the material path is other than vertical or if the process material deviates significantly from the SCHMIDT calibration material, you need to carry out **zero adjustment** and **gain adjustment** as described in chapter 3.4.1 before starting measurement.
- Thread the process material through the measuring and guide rollers, following the red material path symbol on the front of the sensor.

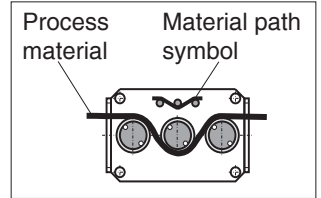

The LCD now shows  the measured line tension.

**1** If the line tension drops below the low alarm limit set according to chapter 3.3.1, the minimum LED is lit.  
If the line tension exceeds the high alarm limit set according to chapter 3.3.1, the maximum LED is lit.

### 3.3 Settings

#### General information:

The defaults for the display unit have been set to match the supplied sensor.

The following default settings will apply to a TS1 sensor with a tension range up to 200.0 cN, for example:

Damping: 6  
Tension range: 200 cN  
Unit of measure: cN  
Alarm function: Off  
Low alarm limit: 20.0  
High alarm limit: 180.0

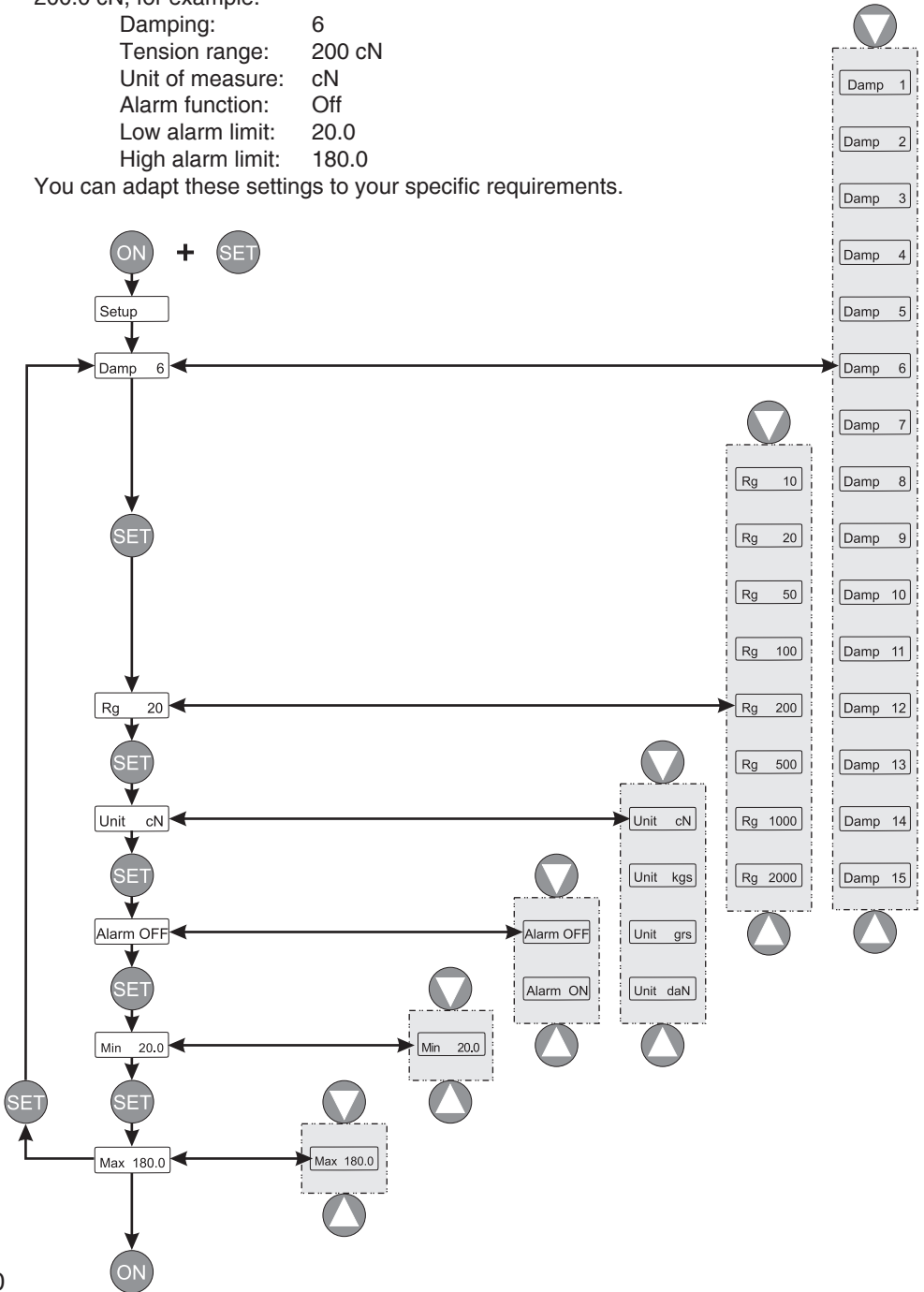

You can adapt these settings to your specific requirements.



### 3.3 Settings (cont.)





#### To change the settings:

- Unit switched on as described in chapter 3.1.1.



- Simultaneously press the  and  keys.

The LCD shows  and then .

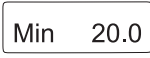
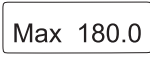
By pressing the  key, you can now go to the individual settings for

Damping:   
Tension range:   
Unit of measure:   
Alarm function:   
Low alarm limit:   
High alarm limit: 

 **The settings you made remain stored in the SCD-1 memory even after the instrument is switched off.**

- Press the  or  key to set the desired value for the selected setting.

- Press  to go to a different setting,  
or

- Press  to save the set value and return to measuring mode.

#### 3.3.1 Changing the settings

##### To change the damping factor:

##### Requirement:

- Unit switched on as described in chapter 3.1.1.

The unit is factory-set to a damping factor of .

The tension values are thereby averaged in the following way for display on the LCD:

$$\frac{9 \text{ old values} + 6 \text{ new values}}{15}$$

15

The damping factor can be modified in 15 steps from 01 = low damping:

$$\frac{1 \text{ old value} + 14 \text{ new values}}{15}$$

15



to 15 = high damping:

$$\frac{14 \text{ old values} + 1 \text{ new value}}{15}$$



15

### 3.3.1 Changing the settings (cont.)

#### To change the setting:

- Simultaneously press the  and  keys.

The LCD shows  and then .

- Press the  or  key to set the desired damping factor.

For example: 

 **The settings you made remain stored in the SCD-1 memory even after the instrument is switched off.**

- Press the  key to save the setting and return to measuring mode.
- or

- Press the  key to change the setting for the:



#### Tension range

The tension range is factory-set for the supplied sensor.

You can also set the tension range for any other sensor that complies with the specifications in chapter 5.

#### To change the setting:

The LCD shows . You can now set the desired tension range.

- Press the  or  key to set the desired tension range.

For example: 

- Press the  key to save the setting and return to measuring mode.
- or

- Press the  key to change the setting for the:



#### Unit of measure

The display unit is factory-set to the unit of measure .

You can also select daN, g or kg for the unit of measure.

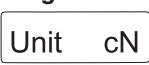
#### To change the setting:

The LCD shows . You can now set the desired unit of measure.

- Press the  or  key to set the desired tension range.

For example: 

- Press the  key to save the setting and return to measuring mode.
- or

- Press the  key to change the setting for the:



### 3.3.1 Changing the settings (cont.)

#### Alarm function

The unit is factory-set to .

#### To change the setting:

The LCD shows .

- Press the  or  key to enable or disable the alarm function.

For example: .

- Press the  key to save the setting and return to measuring mode.
- or

- Press the  key to set the:

 **The settings you made remain stored in the SCD-1 memory even after the instrument is switched off.**

#### Low alarm limit

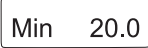

The low alarm limit is factory-set to 10% of the tension range of the supplied sensor.

For example: .

When you change the tension range, the low alarm limit is automatically set to 10% of the newly selected tension range.

#### To change the setting:

The LCD shows .

- Press the  or  key to set the desired low alarm limit.

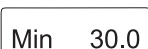
For example: .

- Press the  key to save the setting and return to measuring mode.
- or

- Press the  key to set the:

#### High alarm limit



The high alarm limit is factory-set to 90% of the tension range of the supplied sensor.

For example: .

When you change the tension range, the high alarm limit is automatically set to 90% of the newly selected tension range.

#### To change the setting:

The LCD shows .

- Press the  or  key to set the desired high alarm limit.

### 3.3.1 Changing the settings (cont.)

For example: 

- Press the  key to return to measuring mode.  
or

- Press the  key to return to the **damping factor** setting.

 **The settings you made remain stored in the SCD-1 memory even after the instrument is switched off.**

### 3.4 Calibration of sensors of the TS, FS and MZ series

All tension meters are calibrated with standard materials - such as polyamide mono-filament (PA) - according to the SCHMIDT factory procedure; the material path is vertical. Any difference in process material size and rigidity from the standard material may cause a deviation of the accuracy. In 95% of all industrial applications, the SCHMIDT calibration has been proven to provide the best results and is used for comparative purposes. If required you can also operate the sensor with a material path other than vertical. Should the process material differ significantly from the SCHMIDT calibration material in size, rigidity or shape, we recommend special calibration using customer supplied material. If a different material path (e.g. horizontal) or special calibration using customer supplied material is required, you need to carry out static **zero** and **gain adjustment** as described in chapter 3.4.1.

 **Since the factory calibration for zero and gain is always performed statically, the readings may differ under dynamic load.**

#### 3.4.1 Zero adjustment

- The connected sensor must be threatened in measuring position.
- Switch on the SCD-1, according to chapter 3.1.1, display shows an value.

- Press and hold the key .

- Set the shown display value to zero, by pressing the keys  or .

- Release the key   
The zero value will be restored

 **The zero adjustment must be accomplished after every new activation of the SCD-1**

### 3.4.2 Zero and gain adjustment

#### Requirements:

- Two weights, one corresponding to 10% and one to 90% of the selected tension range, must be provided. Pay attention to the selected unit of measure (cN or kg).
- Required tension range set as described in chapter 3.3.1.
- Sensor mounted at measuring location.



Connect only sensors which comply with the specifications given in chapter 5.

To avoid random noise and malfunctions, make sure the cable connecting the SCD-1 with the sensor is not laid parallel to power lines or highly loaded signal lines, regardless of the type of voltage.





The requirements of the CE specification are only complied with if the SCD-1 is equipped and operated with sensors and connecting cables supplied by Hans Schmidt & Co GmbH. Certification to the CE specification does not extend to, and shall be invalid for any other combination. Under no circumstances shall Hans Schmidt & Co GmbH be held liable for any resulting damage.

- Supplied sensor connected to the SCD-1 at the 8-pin connector.
- AC adapter connected.
- Switch on the SCD-1 as described in chapter 3.1.1.
- Allow approx. 10 minutes for thermal stabilization of the unit.

#### Zero adjustment:

- Thread the process material through the measuring and guide rollers, following the red material path symbol on the front of the sensor.
- Hang a weight that corresponds to 10% of the tension range (pay attention to the correct unit of measure) from the process material, vertically, as shown in fig. 3.4.1. (Always use a fresh portion of the material to be measured.)

- Press and hold the  key .

- Press the ZERO  or  key repeatedly until the tension value on the LCD is equal to the value of the suspended weight.

For example: Sensor model TS1 - 200

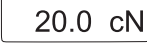
Weight 20 cN = LCD display 

- Release the  key.

### 3.4.2 Zero and gain adjustment (cont.)

#### Gain adjustment:

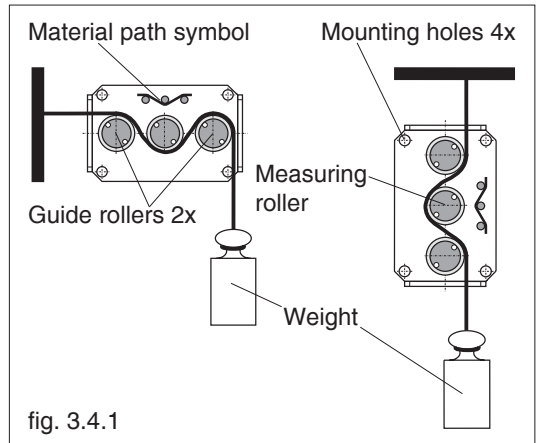



### Requirement:

Zero adjustment carried out.

### To carry out gain adjustment:

- Thread the process material through the measuring and guide rollers.
- Hang a weight that corresponds to 90% of the tension range (pay attention to the correct unit of measure) from the process material, vertically, as shown in fig. 3.4.1. (Always use a fresh portion of the material to be measured.)

- Press and hold the  key.

- Press the GAIN  or  key repeatedly until the tension value on the LCD is equal to the value of the suspended weight.

For example: Sensor model TS1 - 200

Weight 180 cN = Display 180.0 cN

- Release the  key.

**The zero and gain adjustment values are saved automatically after approx. 10 seconds.**





- Check the adjustments with a fresh portion of the process material and repeat the procedure, if required.

**If the adjustment range of the display unit is not sufficient for carrying out the zero and gain adjustments, you can request the relevant calibration instructions from Hans Schmidt & CO GmbH.**

**i**

### 3.4.3 Restoring the factory calibration

- Press and hold the  key.
- Simultaneously press the  and  keys.  
The factory calibration is restored.

## 4 Interfaces

### 4.1 Analog interface

The analog interface in the purple and green mini-DIN ports is provided for customer signal processing or for connecting a line recorder which conforms to the current industrial standard.

Please refer to chapters 2.1, 2.2.1, 2.2.3 and 2.3.2 for the specifications.

### 4.2 Min. - max. interface

The min. - max. interface (open collector) in the green mini-DIN port can be used for connecting external signal devices.

Please refer to chapter 2.1 for the specifications.

### 4.3 Digital interface

#### 4.3.1 The »Tension Inspect 3« program

The »Tension Inspect 3« software from SCHMIDT is described in a separate user manual.

#### 4.3.2 Windows terminal program

The measured values can be transmitted over the RS-232 interface to a PC. You can connect the computer to the interface of the SCD-1 by using the EK0647 special cable which is available as an accessory. The pin assignment of the interface is described in chapter 2.2.

#### Requirement:

A communication program, such as Terminal or HyperTerminal (provided on MS Windows Version 3.0 or later), must be installed and configured on the computer.

#### Command for communication with a PC (polling)

ASCII Code	Function	Description
d	Send	Transmit current reading to PC once.

### 4.4 Online sensor specifications

TS series (models TS1, TSP, TSR, TSH, TSL, TSF, TSF1, TSW, TSB1, TSB2)

FS series (models FS1, FSP, FSR, FSH, FSL, FSW, FSB1)

MZ series (models MAZD, MBZD, MAZF, MBZF, MBZB, MZ1, MZH, MZB1)

Calibration: According to SCHMIDT factory procedure

Accuracy: For 10% to 100% of range:

TS:  $\pm 1$  % full scale

FS:  $\pm 1.5$  % full scale

MZ:  $\pm 2$  % full scale

MZ1, MZH, MZB1: 1.5 % full scale

Remainder of range and

Other calibration material:  $\pm 3$  % full scale or better

Overload protection: 100 % of range

Measuring principle: Strain gauge bridge

Measuring roller deflection: 0.5 mm max.

Signal processing: Analog

Output signal: 0 - 1 V DC (standard)

Damping ( $f_d$ ): Standard: 30 Hz (other values on request)

Temperature coefficient: Gain: less than  $\pm 0.05\%$  full scale/ $^{\circ}\text{C}$

Temperature range: 10 - 45  $^{\circ}\text{C}$

Air humidity: 85 % RH, max.

Power supply: TS standard: + 12 to + 24 V DC (21 mA, regulated)

FS, MZ standard: + 15 to + 24 V DC (21 mA, regulated)

Further technical details are provided in the instruction manual for the sensors.

## 5 Service and maintenance

The tension meter is easy to maintain. Depending on operating time and load, the tension meter should be checked according to the locally valid regulations and conditions.

## 6 Cleaning

For cleaning the unit, do not use any



### **AGGRESSIVE SOLVENTS**

such as trichloroethylene or similar chemicals.



### **NO WARRANTY OR LIABILITY**

shall be accepted for damage resulting from improper cleaning.

## 7 Verification intervals

The question of finding the right frequency of calibration accuracy verification depends on several different factors:

- ➔ Operating time and load of the SCHMIDT tension meter
- ➔ Tolerance band defined by the customer
- ➔ Changes of the tolerance band compared to previous verifications of calibration

Therefore, the interval between verifications must be determined by the user's Quality Assurance Department based on the user's experience.

Assuming normal operating time and load as well as careful handling of the tension meter, we recommend a verification interval of 1 year.

## 8 Correspondence

Should you have any questions regarding the instrument or instruction manual, or their use, please indicate above all the following details which are given on the ID plate:

- 1) Model
- 2) Serial number

## 9 Repairs

### **Shipping instructions:**

We kindly ask for return free of charge for us, if possible by airmail parcel. All occurring charges, if any (such as freight, customs clearance, duty etc.), will be billed to customer. For return from foreign countries, we ask you to include a proforma invoice with a low value for customs clearance only, e.g. 50 Euro, each and to advise the shipment in advance by fax or eMail.



**To avoid unnecessary follow-up questions, and the resulting loss of time or possible misunderstandings, please return the instrument with a detailed fault description to our service department. Please indicate in your order whether you require an Inspection Certificate 3.1 according to DIN EN 10204.**

**Service address: Hans Schmidt & Co GmbH  
Schichtstr. 16  
D-84478 Waldkraiburg  
Germany**

Notes:

---

---

**SCHMIDT-Test-Instruments**  
indispensable in production monitoring,  
quality control and automation  
We solve your measuring problems:



Tension Meter



Force Gauge



Torque Meter



Tachometer



Speed- and Lengthmeter



Electronic Lengthmeter



Stroboscope



Screen Printing Tension Meter



Thickness Gauge



Yarn Package Durometer and Shore Durometer



Sample Cutter



Balance



Moisture Meter



Leak Tester

**More than 75 years - Worldwide -**

**Hans Schmidt & Co GmbH**

**Mailing address:**

P. O. B. 1154  
84464 Waldkraiburg Germany

**Shipping address:**

Schichtstr. 16  
84478 Waldkraiburg Germany

**Phone:**

int. + 49 / (0)8638 / 9410-0

**Fax:**

int. + 49 / (0)8638 / 4825

int. + 49 / (0)8638 / 67898

**e-mail:**

info@hans-schmidt.com

**Internet:**

http://www.hans-schmidt.com