

Tension Meter

SCHMIDT
control instruments



Edition PT 01.0.E

PT Series

Model PT-100
PT-100-L

Instruction Manual

Valid as of: 15.04.2011 • Please keep the manual for future reference!



SCHMIDT · 1ST IN TENSIONMETERS WORLDWIDE



Contents

1 Warranty and liability	3
1.1 Notices within the instruction manual.....	3
1.2 Responsibilities of the operating company.....	3
1.3 Responsibilities of the personnel	3
1.4 Informal safety measures.....	4
1.5 Training of the personnel	4
1.6 Intended use	4
1.7 Dangers in handling the device.....	4
1.8 Copyright.....	4
1.9 Declaration of conformity, RoHs II and WEEE registration	4
2 Available models	5
2.1 Specifications	5
2.2 Delivery includes	5
2.3 Unpacking	6
3 Initial setup and operating procedure	6
3.1 Notes before starting measurement.....	6
3.2 Operating elements.....	6
3.3 Setup.....	7
3.3.1 Charging the battery	7
3.3.2 Switch-on.....	7
3.3.3 Switch-off.....	7
3.3.4 Selecting the units of measure	8
3.3.5 Zero adjustment of the measuring position (auto zero)	8
3.3.6 Selecting the operating mode.....	9
3.4 Taking a measurement	9
3.4.1 Measuring in tension mode	9
3.4.2 Measuring in speed mode	10
3.4.3 Measuring in length mode	10
3.4.4 Displaying the average	12
3.4.5 Activating damping mode	13
3.4.6 Changing the damping factor	13
3.5 Error messages.....	14
3.6 Dynamic verification of measuring accuracy.....	14
3.7 Static verification of measuring accuracy.....	15
4 Service and maintenance	15
4.1 Rollers	15
5 Cleaning	15
6 Verification intervals	16
7 Correspondence	16
8 Repairs	16

1 Warranty and liability

In principle, the supply of the device is subject to our “General Conditions of Sale and Delivery.” These have been provided to the operating company on conclusion of the contract, at the latest.

Warranty:

- SCHMIDT tension meters are warranted for 12 months.

Parts subject to wear, electronic components and measuring springs are not covered by the warranty. No warranty or liability will be accepted for bodily injury or property damage resulting from one or several of the following causes:

- Misuse or abuse of the device.
- Improper mounting, commissioning, operation and maintenance of the device (e.g. verification interval).
- Operation of the device if any safeguards are defective or if any safety and protection precautions are not properly installed or not operative.
- Failure to comply with the notices in the instruction manual regarding transport, storage, mounting, commissioning, operation, maintenance and setup of the device.
- Any unauthorized structural alteration of the device.
- Insufficient inspection of device components that are subject to wear.
- Opening the device or improper repair work.
- Disasters caused by the effects of foreign objects or by force majeure.

1.1 Notices within the instruction manual

The fundamental prerequisite for the safe handling of this device and its troublefree operation is the knowledge of the basic safety notices and safety instructions.

These instruction manual contains the most important notices for the safe operation of the device.

These instruction manuals, in particular the safety notices, must be observed by any person who works with the device. In addition, the locally valid rules and regulations for the prevention of accidents must be complied with.

The representations within the instruction manual are not true to scale.

The dimensions given are not binding.

General indications of direction, such as FRONT, REAR, RIGHT, LEFT apply when viewing the front of the device.

1.2 Responsibilities of the operating company

In compliance with the EC Directive 89/655/EEC, the operating company agrees to only permit persons to work with the device who:

- are familiar with the basic regulations on industrial safety and accident prevention and who have been trained in handling the device.
- have read and understood the chapter on safety and the warning notices in these instruction manual and have confirmed this with their signatures.
- are examined regularly on their safe and conscientious working method.

1.3 Responsibilities of the personnel

All persons who work with the device agree to perform the following duties before starting work:

- to observe the basic regulations on industrial safety and accident prevention.
- to read the chapter on safety and the warning notices in these instruction manual and to confirm with their signatures that they have understood them.

1.4 Informal safety measures

The instruction manual must always be kept on hand where the device is operated. Apart from the instruction manual, the generally and locally valid regulations on accident prevention and environmental protection must be provided and complied with.

1.5 Training of the personnel

Only trained and instructed personnel is permitted to work with the device. The responsibilities of the personnel must be clearly defined for mounting, commissioning, operation, setup, maintenance, and repair. Trainees may only work with the device under the supervision of experienced personnel.

1.6 Intended use

The device is intended exclusively to be used for measuring tension, yarn speed and yarn length. Any other use or any use exceeding this intention will be regarded as misuse. Under no circumstances shall Hans Schmidt & Co GmbH be held liable for damage resulting from misuse.

The intended use also includes:

- Complying with all notices included in the instruction manual and observing all inspection and maintenance works.

1.7 Dangers in handling the device

The device was designed according to the state of the art and the approved safety standards. Nevertheless, its use may cause serious or fatal injury to the user or third persons, and/or an impairment of the device or of other material assets.

The device may only be applied:

- For its intended use in a faultless condition with regard to the safety requirements.
- Malfunctions that could impair safety must be remedied immediately.
- Personal protective equipment must be used according to the EC Directive 89/686/EEC.



The device must not be operated in potentially explosive areas and must not come into contact with aggressive substances.

1.8 Copyright

The copyright on these instruction manual remains with the company Hans Schmidt & Co GmbH.

These instruction manual is intended for the operating company and its personnel only. They contain instructions and notices that may only be reproduced on the prior written permission of

Hans Schmidt & Co GmbH

and under indication of the complete reference data.

Violations will be prosecuted.

1.9 Declaration of conformity, RoHs II and WEEE registration

In compliance with the EU Directives 2014/30/EU and 2011/65/EU



Hans Schmidt & Co GmbH is registered in compliance with the German Electrical and Electronic Equipment Act (ElektroG) under WEEE Reg. No. DE 48092317.

2 Available models



These instruction manual refer to model PT-100 and PT-100-L of the PT series.

Model	Measuring Range Tension	Measuring Range Speed*	Measuring Range Length*	SCHMIDT Calibration Material**
PT-100	0.5 - 100.0 cN 0.5 - 100.0 g			PA: 0.20 mm Ø
PT-100-L	0.5 - 100.0 cN 0.5 - 100.0 g	0 - 1999 m/min 0 - 1999 in/min	0 - 1999 m 0 - 1999 in	PA: 0.20 mm Ø

* Speed and length measurement is only possible with a thread tension higher than 1 cN.

** Suitable for 95% of all applications. PA = Polyamide Monofilament.

International unit of tensile force: 1 cN = 1.02 g = 0.01 N

2.1 Specifications

Calibration:	According to SCHMIDT factory procedure
Accuracy:	± 1.5 % full scale ± 1 digit (not for length and speed measurement)
Measuring units:	cN, g available m, in, m/min, in/min (only PT-100-L)
Overload protection:	200 % full scale
Measuring principle:	Strain gauge bridge
Damping:	Selectable electronic damping (moving averaging)
Display update rate:	2 times per second
Display:	3 ½ digit LCD, 9 mm high
Power supply:	LiPo accumulator (40 h continuous use, 3.5 charging time) , USB AC adapter 110 - 240 V AC with 4 adapters (EU/USA/ UK/AUS-NZ)
Auto power off:	Automatically after approx. 3 min. of non-use
Temperature range:	10 - 45° C
Air humidity:	85 % RH, max.
Housing material:	Aluminium
Dimensions:	141 x 36 x 22 mm (L x W x H)
Weight net (gross):	Approx. 170 g (500 g)

Guide rollers:

V-grooved	Line Speed max. m/min	Roller Material
Standard	2000	Aluminium hardcoated

2.2 Delivery includes

- Tension meter
- USB AC adapter with 4 adapters (EU/USA/UK/AUS-NZ)
- USB cable
- Certificate of compliance with the order 2.1 under EN 10204
- Sensor (only PT-100-L)
- Magnet (only PT-100-L)
- Instruction manual
- Carrying case

2.3 Unpacking

Unpack the tension meter and inspect it for any shipping damage.

Notices of defect must be announced immediately, at the latest within 7 days on receipt of the goods.

3 Initial setup and operating procedure

3.1 Notes before starting measurement



Have you read and understood the instruction manual, in particular chapter 1 “Warranty and liability” ?

You are not permitted to operate the tension meter before doing so.

Before working with the instrument you must put on your personal protective clothing, if necessary. For example, eye protectors, gloves, etc.

To avoid damage, do not move the rollers by hand.

Tensions that exceed the tension range of the instrument by more than 100% may cause permanent damage to the measuring spring and must be avoided under any circumstances.

- 1** • The ID plate with CE mark and serial number is provided on the bottom of the tension meter; the calibration label (optional) and the SCHMIDT Quality Seal is provided on the side.

ID plate with serial number

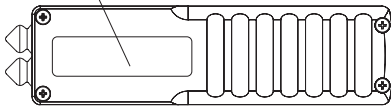
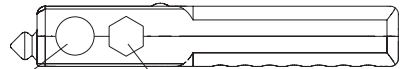

fig. 3.1

SCHMIDT-quality seal



Calibration label (option)

3.2 Operating elements

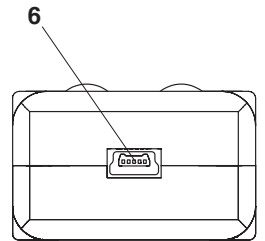
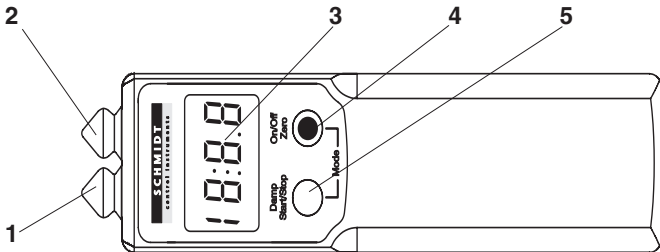



fig. 3.2

- 1 Measuring roller (tension/length/speed)
- 2 Measuring roller (tension)
- 3 Display
- 4 On/Off/Zero button
- 5 Damp (damping)/Start/Stop button
- 6 USB Port

3.3 Setup

The tension meter comes with a built-in rechargeable LiPo battery, which has been charged at the factory. The tension meter can only be switched on if the battery is still working, i.e. if the battery has enough charge. If the instrument does not power up or if the battery level indicator shows only one bar  after power-up (chapter 3.3.2), the battery needs to be recharged.



To ensure maximum battery life, avoid discharging it completely or charging it frequently for short periods.

The battery should not be stored for a prolonged time when empty.

After a maximum storage period of one year, the battery has to be recharged.

3.3.1 Charging the battery



The battery can only be charged at a temperature between +5 °C and +45 °C. Before you connect the AC adapter, verify that the supply voltage is correct (100 V - 240 V).

Hans Schmidt & Co. GmbH provides no warranty or liability for any damage resulting from the use of AC adapters from other manufacturers.

To charge the battery, connect the cable of the AC adapter to the USB port.

When the battery is fully charged, the battery level indicator will show 3 bars . The charging time is approx. 3.5 hours.



Battery overcharging is not possible

3.3.2 Switch-on

- Press the  button.

The Display then momentarily shows the tension range and the software version, e.g. E 1.0.

- After that the display shows



- The instrument subsequently carries out a self test and the zero adjustment (chapter 3.3.5)

The display shows

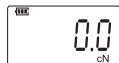

, the tension meter is now ready to operate.

3.3.3 Switch-off

Auto power off:

- The tension meter switches off automatically after 3 minutes of non-use.

Manual switch-off:

- Press the  button for about 7 seconds.

3.3.4 Selecting the units of measure



You can set the instrument to cN or g for tension measurements and to m or inch for length measurements. The default settings are cN and m.

Requirement:

Tension meter switched off as described in chapter 3.3.3.



- Press and hold the  button until the display shows the currently selected units of

measure .

- Release the  button and then press the  button to select the units of measure you want to use for your tension, length and speed measurements.
- Press the  button to save the selected units of measure.

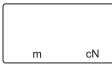
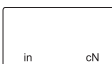
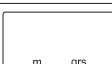

The unit for speed measurements results from the unit selected for length measurements.

Reading on Display	Unit of Measure Tension Mode	Unit of Measure Length Mode	Unit of Measure Speed Mode
	centinewton (cN)	meter (m)	meters per minute (m/min)
	centinewton (cN)	inch (in)	inches per minute (in/min)
	gram (g)	meter (m)	meters per minute (m/min)
	gram (g)	inch (in)	inches per minute (in/min)

3.3.5 Zero adjustment of the measuring position (auto zero)

Zero adjustment is automatically carried out for the current measuring position.



Zero adjustment must be carried out whenever the tension meter does not display “0” in measuring position. The process material must not yet be inserted!

Requirement:

- Tension meter switched on as described in chapter 3.3.2.

To carry out zero adjustment:

- Hold the tension meter in the desired measuring position. Be careful to hold the instrument absolutely steady.
- Press the  button.

The display momentarily shows  and then switches to .

The tension meter is now adjusted for the new material path and is ready to measure.

3.3.6 Selecting the operating mode

The following operating modes are available:



- Tension mode (F) - PT-100 and PT-100-L
- Length mode (L) - PT-100-L only
- Speed mode (S) - PT-100-L only

Requirement:



- Tension meter switched on as described in chapter 3.3.2.

After power-up, the instrument is in tension mode (F) by default.

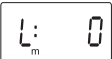

You can cycle through the operating modes by simultaneously pressing the ○ and ● button.

Tension mode: The display briefly shows  and then .

Press the ○ and ● button.

Length mode: The display briefly shows  and then .

Press the ○ and ● button.

Speed mode: The display briefly shows  and then .



The last operating mode used is not stored in memory when you turn off the instrument. After power-up, the tension mode is always active by default.

3.4 Taking a measurement

3.4.1 Measuring in tension mode

Requirements:

Switch on the tension meter (chapter 3.3.2), carry out zero adjustment if required (chapter 3.3.5), change the damping factor if necessary (chapter 3.4.6), and select the tension mode (chapter 3.3.6) and the required unit of measure (chapter 3.3.4).

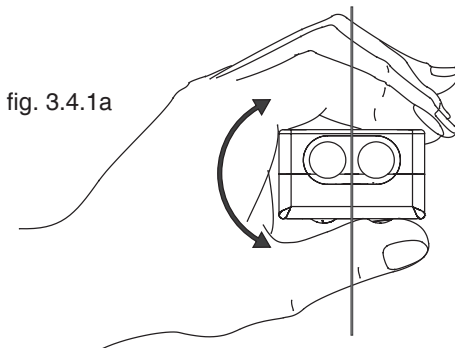

fig. 3.4.1a

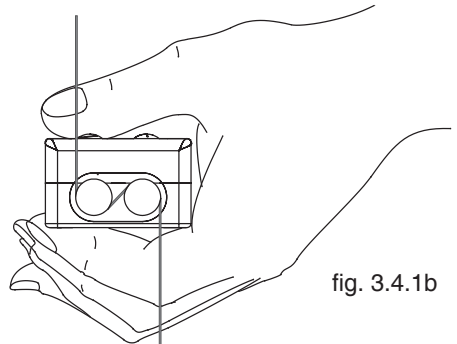

fig. 3.4.1b

3.4.1 Measuring in tension mode (cont.)

To insert the process material:

- Place the process material between the two rollers (fig. 3.4.1a).
 - Rotate the tension meter by approx. 180 degrees (fig. 3.4.1b).
- It is important to assure that the process material runs smoothly over the rollers.

To measure the process material:

The display now shows the measured tension values.
Error messages which might be displayed are described in chapter 3.5.

Damping:

If tension fluctuates, the damping feature should be enabled as described in chapter 3.4.5 or the damping factor should be adjusted as described in chapter 3.4.6.

To remove the process material:

- Rotate the tension meter by 180 degrees.
- Remove the process material.

3.4.2 Measuring in speed mode

Requirements:

Switch on the tension meter (chapter 3.3.2) and select the speed mode (chapter 3.3.6).

- Insert the process material as described in chapter 3.4.1.
- Press the  button.
- The display now shows the measured values.

3.4.3 Measuring in length mode

1 While a length measurement is active, “:” blinks on the display.



Continuous measurement

The measurement is performed for as long as process material is run over the rollers.

Requirements:

Switch on the instrument (chapter 3.3.2) and select the length mode (chapter 3.3.6) and the unit of measure (chapter 3.3.4).

1. Press and hold the  button.

The length mode settings are indicated on the display.

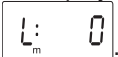
2. Press the  button until the display shows .

3. Insert the process material as described in chapter 3.4.1.

This activates the length measurement.

4. Press the  button to zero the display and start a new measurement.

The previous reading is not saved.

5. The measurement stops when you remove the process material as described in chapter 3.4.1.

3.4.3 Measuring in length mode (cont.)

Measuring with manual start/stop signal





The measurement is performed for a user-defined time.

Requirements:

Switch on the instrument (chapter 3.3.2) and select the length mode (chapter 3.3.6) and the unit of measure (chapter 3.3.4).

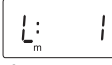
1. Press and hold the  button.

The length mode settings are indicated on the display.

2. Press the  button until the display shows .
3. Insert the process material as described in chapter 3.4.1.
4. Then press the  button to start the length measurement.
5. When you want to stop measuring, press the  button once again. The measured value is displayed.
4. To zero the display, press the  button. You can then start a new measurement. The previous reading is not saved.



To perform measurements using a manual start/stop signal, make sure that no sensor signal is transmitted to the instrument. For this purpose, remove the magnet from the machine or disconnect the sensor from the instrument.

Measuring with automatic start/stop signal

The measurement is performed for a user-defined number of machine revolutions.

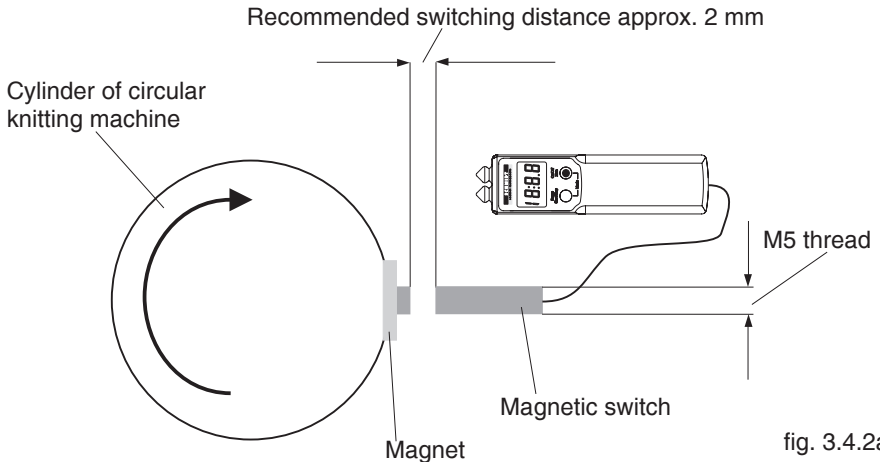

The model PT-100-L features an adjustable counter for up to 10 cylinder revolutions of the knitting machine. The cylinder revolutions are monitored by a magnetic switch.

To use this feature, the supplied magnet must be mounted to the cylinder of the knitting machine by using an M5 flat head bolt. The supplied magnetic switch is fitted to the stationary part of the knitting machine so that it is at the same height as the supplied magnet (fig. 3.4.2b). The switching distance between the supplied magnet and magnetic switch should be set to about 2 mm with the adjusting nut and lock nut of the magnetic switch.

3.4.3 Measuring in length mode (cont.)

Mounting example:

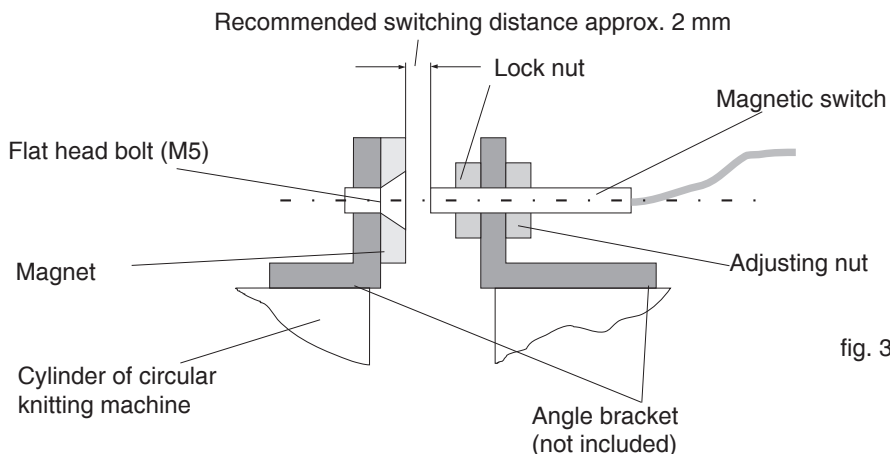
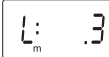

fig. 3.4.2b

1. Press and hold the ● button.
The length mode settings are indicated on the display.
2. Press the ○ button to set the desired number of machine revolutions
(e.g.  3 revolutions).
3. Insert the process material as described in chapter 3.4.1 and press the ● button.
4. On receiving the first switching pulse from the magnetic switch, the instrument starts counting the defined number of revolutions, starting from zero.
The first switching pulse from the magnetic switch also triggers the measurement and display of the filament length.
5. After the defined number of revolutions, the instrument stops measuring the filament length.
The display shows the measured filament length.

To start a new measurement, zero the display by pressing the ● button.
The previous reading is not saved.

3.4.4 Displaying the average

In the tension and speed modes, you can display the average of the last measurement process as soon as you stop the measurement.

Requirement:

The process material has to be removed on completion of the measurement.

- Press the ● button to display the average.



After you display the average or turn off the instrument, the average cannot be displayed again.

3.4.5 Activating damping mode



Damping can only be activated and changed in the tension mode.

The tension meter is equipped with an electronic damping which ensures steady readings when tension fluctuates. This is achieved by averaging the measured values at the set update rate. Before switching on the damping mode, it is recommended that you measure the first values without damping enabled.

Requirements:

- Process material inserted as described in chapter 3.4.1.
- The display has shown the first tension values.

To switch on damping:

- Press the  button.

The display shows the set damping factor e. g. 

- Release the  button.

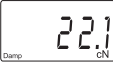
The display shows  damp below the currently measured value.

To switch off damping:

- Press the  button.

The display shows  only the currently measured value.

3.4.6 Changing the damping factor

The tension meter is factory preset to a factor of 06. The tension values are thereby averaged for the display in the following way:

$$\frac{6 \text{ old values} + 4 \text{ new values}}{10}$$

The damping factor can be modified in 15 steps from 01 = low damping:

$$\frac{1 \text{ old value} + 9 \text{ new values}}{10}$$

to 15 = high damping:

$$\frac{9 \text{ old values} + 1 \text{ new value}}{10}$$



Requirement:

- Tension meter switched on as described in chapter 3.3.2.

Procedure:

- Press and hold the .

The display shows the currently selected damping factor.

- You can now change the damping factor with the .
- Release the .

The tension meter returns to the measuring mode.

3.5 Error messages

Error message 1:

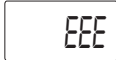

- The display shows .

The upper limit of the measuring range was exceeded by more than 100%.
Reduce the applied load.

or

Auto Zero is no longer possible.

Return the tension meter to the manufacturer for factory calibration.

Error message 2:



- The display shows .

The lower limit of the measuring range was fallen below by more than 100%.
Properly insert the process material.

or

Auto Zero is no longer possible.

Return the tension meter to the manufacturer for factory calibration.

3.6 Dynamic verification of measuring accuracy

All tension meters are calibrated with standard materials - such as polyamide monofilament (PA) - according to the SCHMIDT factory procedure. The diameters are given in chapter 2. Any difference in process material size and rigidity from the standard material may cause a deviation of the accuracy. In 95% of all industrial applications, the SCHMIDT calibration has been proven to provide the best results and is used for comparative purposes. The tension meter is factory calibrated for a vertical material path (fig. 3.7).

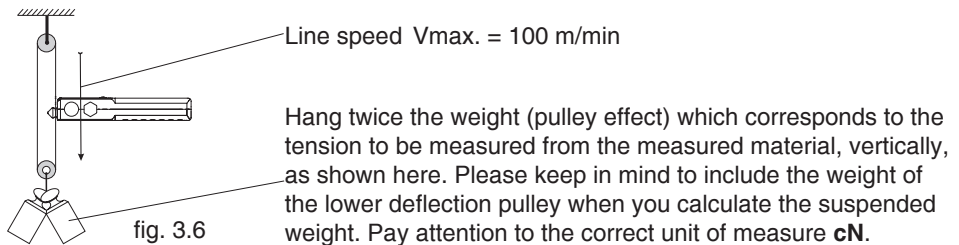

- 1 The tension meter has been calibrated dynamically according to the SCHMIDT factory procedure. Therefore, differences may occur between static and dynamic readings.

3.7 Static verification of measuring accuracy

All tension meters are calibrated with standard materials - such as polyamide monofilament (PA) - according to the SCHMIDT factory procedure. The diameters are given in chapter 2. Any difference in process material size and rigidity from the standard material may cause a deviation of the accuracy. In 95% of all industrial applications, the SCHMIDT calibration has been proven to provide the best results and is used for comparative purposes. The tension meter is factory calibrated for a vertical material path (fig. 3.6).

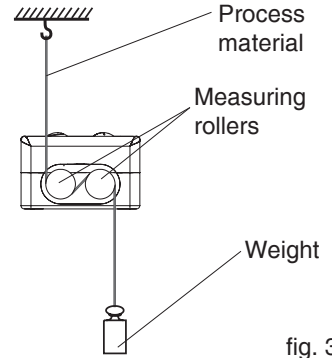

fig. 3.7

Requirement:

The required reference weight must be available.

Verification procedure:

- Hang a weight which corresponds to the tension to be measured from the process material, vertically, as shown in fig. 3.7.

Pay attention to the correct unit of measure.

- Insert the process material as described in chapter 3.4.1.

- The tension value shown on the display should be equal to the value of the suspended weight (pay attention to the measuring units).

If this procedure shows a deviation, the tension meter has to be returned to the manufacturer for factory calibration.



**The tension meter cannot be calibrated by the user.
Factory calibration of the tension meter is essential.**

4 Service and maintenance

The tension meter is easy to maintain. Depending on operating time and load, the tension meter should be checked according to the locally valid regulations and conditions (as described in chapter 3.6 and 3.7). The use of other test methods than the procedure described in chapter 3.6 and 3.7 may cause deviating measuring results.

4.1 Rollers

You should regularly inspect the rollers to assure that they are running easily and smoothly. The **rollers** can only be changed by the manufacturer.

5 Cleaning

For cleaning the unit, do not use any



AGGRESSIVE SOLVENTS

such as trichloroethylene or similar chemicals.



NO WARRANTY OR LIABILITY

shall be accepted for damage resulting from improper cleaning.

6 Verification intervals

The question of finding the right frequency of calibration accuracy verification depends on several different factors:

- Operating time and load of the SCHMIDT tension meter
- Tolerance band defined by the customer
- Changes of the tolerance band compared to previous verifications of calibration

Therefore, the interval between verifications must be determined by the user's Quality Assurance Department based on the user's experience.

Assuming normal operating time and load as well as careful handling of the tension meter, we recommend a verification interval of 1 year.

7 Correspondence

Should you have any questions regarding the instrument or instruction manual, or their use, please indicate above all the following details which are given on the ID plate:

- 1) Model
- 2) Serial number

8 Repairs

Shipping instructions:

We kindly ask for return free of charge for us, if possible by airmail parcel. All occurring charges, if any (such as freight, customs clearance, duty etc.), will be billed to customer. For return from foreign countries, we ask you to include a proforma invoice with a low value for customs clearance only, e.g. 50 Euro, each and to advise the shipment in advance by fax or eMail.

1 To avoid unnecessary follow-up questions, and the resulting loss of time or possible misunderstandings, please return the instrument with a detailed fault description to our service department. Please indicate in your order whether you require an Inspection Certificate 3.1 according to DIN EN 10204.

Service address:

Hans Schmidt & Co GmbH
Schichtstr. 16
D-84478 Waldkraiburg
Germany

More than 75 years - Worldwide -

Hans Schmidt & Co GmbH

Mailing address:

P. O. B. 11 54
84464 Waldkraiburg Germany

Shipping address:

Schichtstr. 16
84478 Waldkraiburg Germany

Phone:

int. + 49 / (0)8638 / 9410-0

Fax:

int. + 49 / (0)8638 / 4825
int. + 49 / (0)8638 / 67898

e-mail:

info@hans-schmidt.com

Internet:

<http://www.hans-schmidt.com>